

Caractéristiques techniques *Technical specifications*



Ni Infrarouge Ni Ultra Violet



Référence <i>Reference</i>	SOLELUX L30PE6051
<b>Puissance</b> <i>Power</i>	60 W
<b>Tension d'entrée</b> <i>Input voltage</i>	90-305 VAC 50-60 Hz
<b>Cosinus Phi</b> <i>Power factor</i>	≥ 0,95
<b>Température de jonction</b> <i>Junction temperature</i>	120°C
<b>Gradation</b>	En option
<b>Consommation totale</b> <i>Total Consumption</i>	70 W
<b>Nombre de Source</b> <i>Number of Sources</i>	30 x 2W
<b>Flux LED</b> <i>LED Output</i>	100 à 130 Lm/W
<b>Type de LED</b> <i>LED type</i>	OSRAM / Philips / LG
<b>Durée de vie</b> <i>Lifespan</i>	> 50 000 h
<b>IRC</b>	RA >70
<b>Température de couleur</b> <i>Color temperature</i>	A la demande blanc parmi : 4000/5000/6000/7000 K rouge,vert,bleu,jaune <i>On demand : white 4000/5000/7000 K)</i>
<b>Flux lumineux</b> <i>Luminous flux</i>	6000 Lm
<b>Température d'utilisation</b> <i>Environnement temperature</i>	- 40.00°C /+50.00°C
<b>Protection IP</b> <i>IP Protection</i>	IP 65
<b>Dimensions</b> <i>Dimensions</i>	327mm/366mm/91mm
<b>Poids</b> <i>Weight</i>	4.5 Kgs
<b>Optique</b> <i>Optic</i>	Collimateur adapté
<b>Habillage</b> <i>Housing</i>	Aluminium Mécano-soudé
<b>Angle d'éclairage</b> <i>Viewing Angle</i>	15°x15° / 30°x30° / 60°x60° / 60°x135° / 85°x135°
<b>Hauteur d'utilisation</b> <i>Recommended Height</i>	< 6 m
<b>Protection IK</b> <i>IK Protection</i>	IK 07
<b>Classe de protection</b> <i>Protection Safety class</i>	1
<b>Tenue au vent</b> <i>Wind resistance</i>	100 Km/h

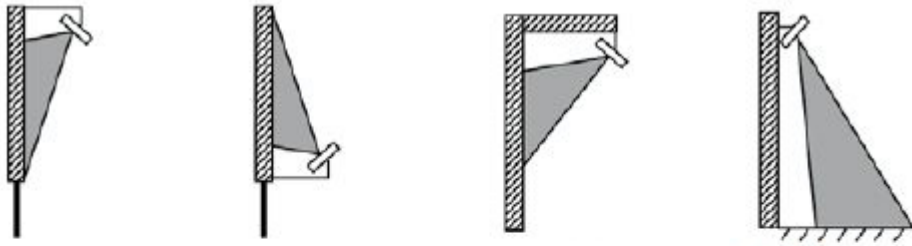

EXEMPLE DE FIXATION



Tableau d'équivalence approximative  
entre LED et Iodure Métallique

 Projecteur LED	 Projecteur Iodure Métallique
60W / 80W	150W
100W / 150W	250W
200W / 250W	400W
300W / 350W	750W
400W / 500W	1000W
600W	1500W

# Données photométriques en 15° x 15°

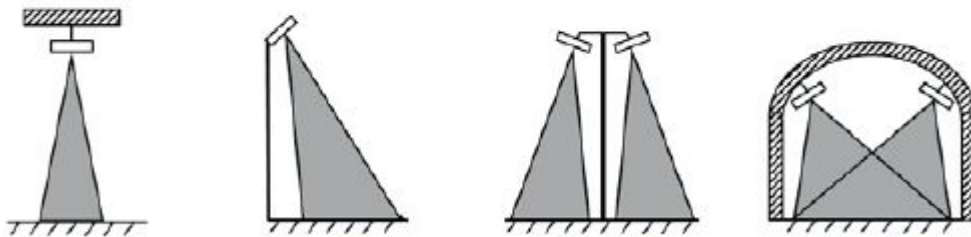
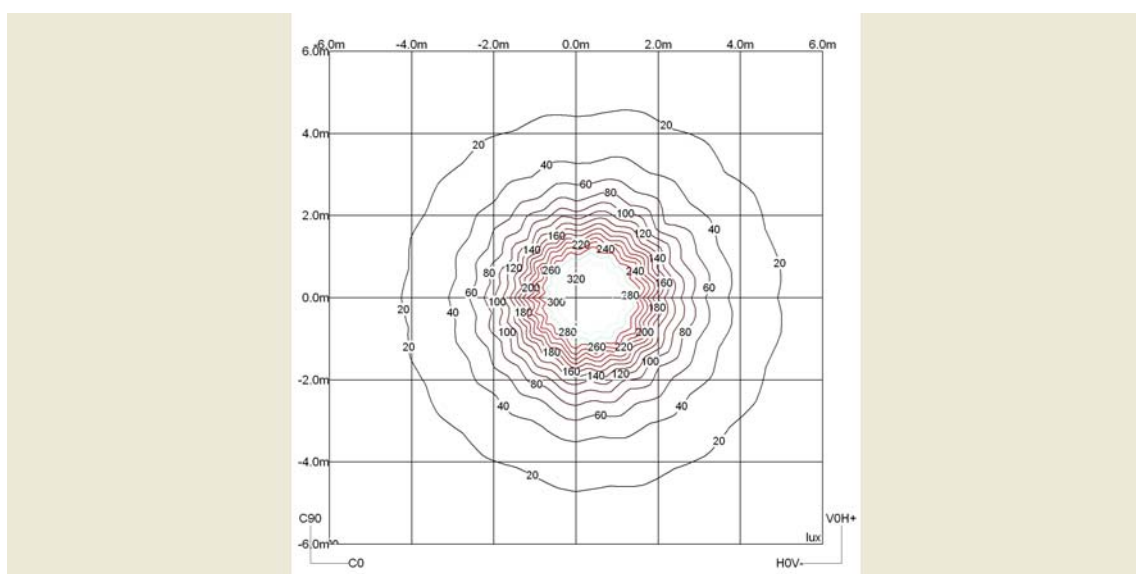
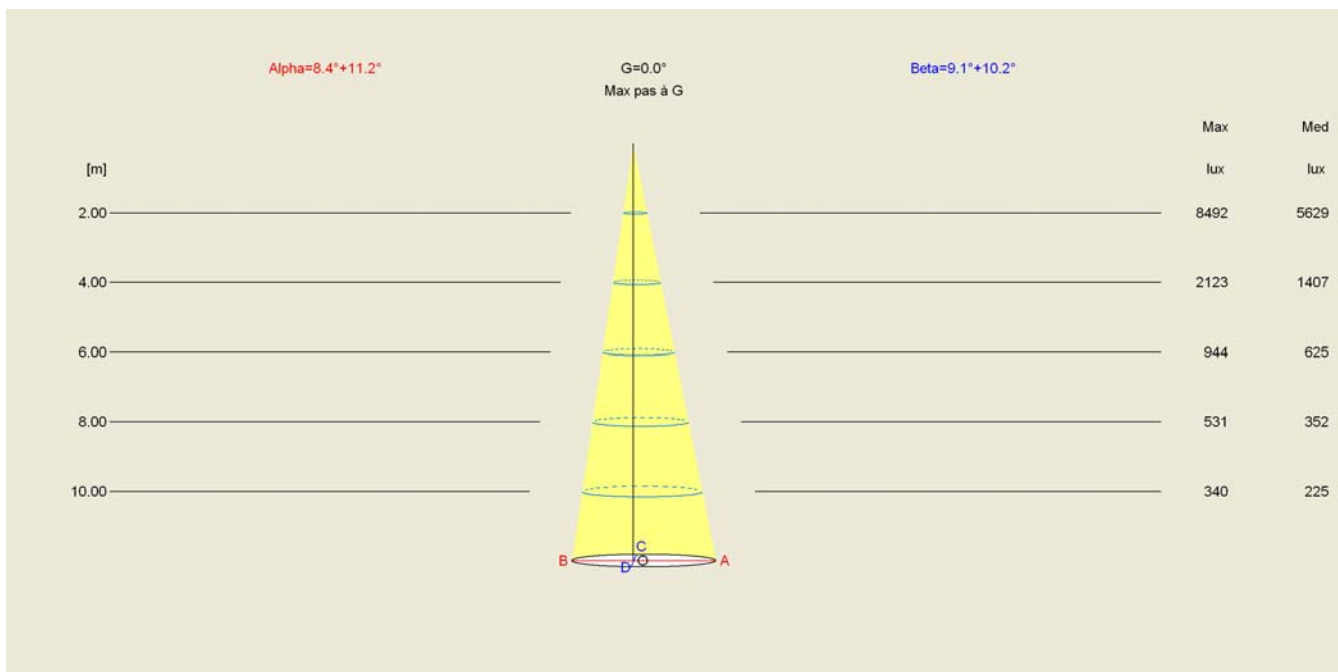

1mm x 1mm

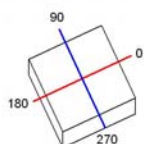

C Demi-plans

180.0 — 0.0

270.0 — 90.0

Flux 7972.30 lm  
Maximum 34079.50 cd  
Position C=350.00 G=2.70  
Rendement: 100.04%  
Date: 01-01-1998  
Asymétrique

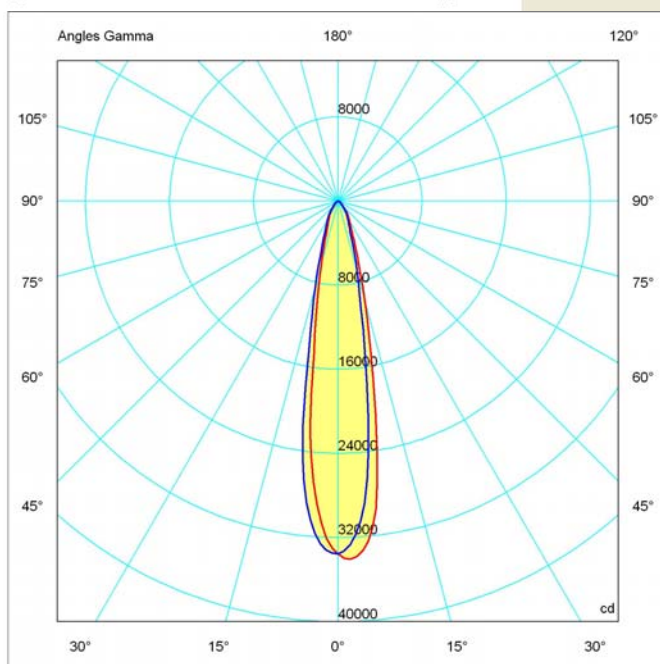

Cité de la Photonique - Pôle de Compétitivité Route des Lasers - 9 allée des Lumières / 11 avenue de Canteranne - 33600 Pessac France Tel +33 (0)5 57 00 01 40 / Fax +33(0)5 57 00 01 41

Siège Social : 12 avenue de la libération – 33700 Mérignac – France

E-mail : [luxener@luxener.com](mailto:luxener@luxener.com) [www.luxener.com](http://www.luxener.com)

# Données photométriques 30° x 30°

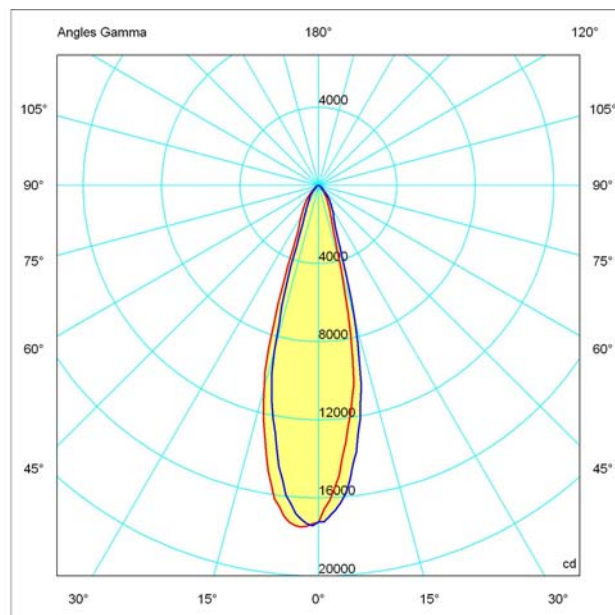
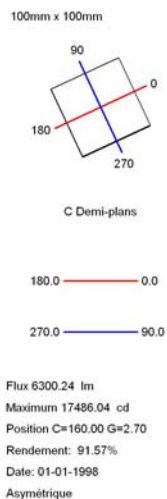
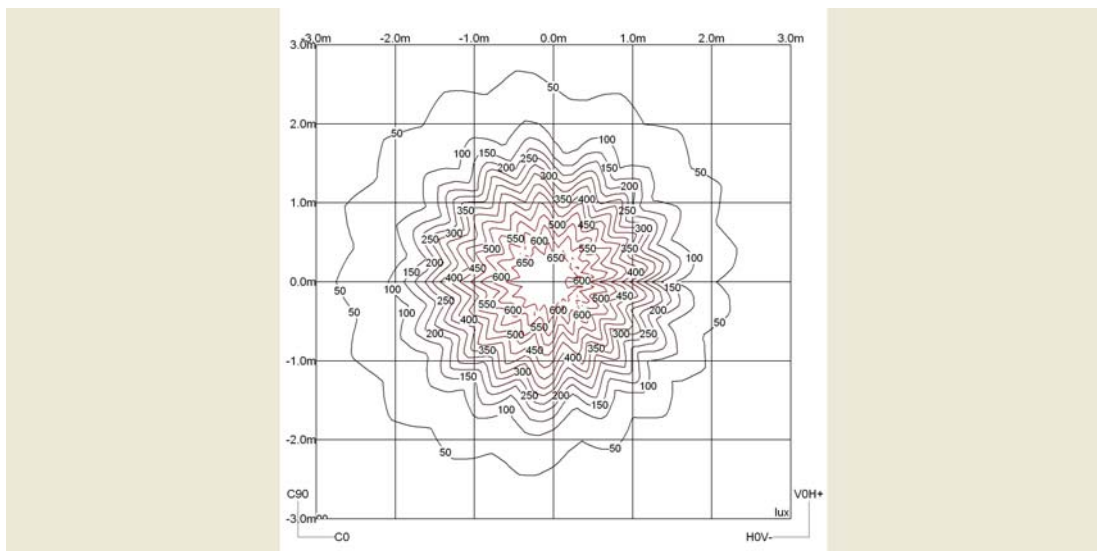
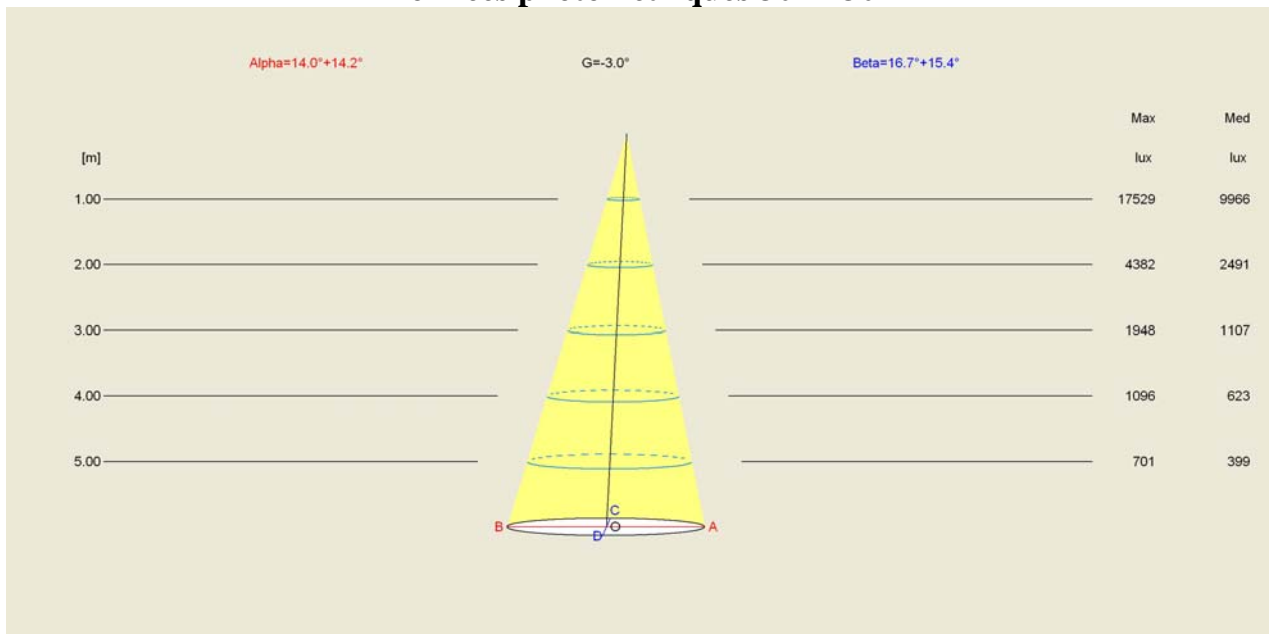

Cité de la Photonique - Pôle de Compétitivité Route des Lasers - 9 allée des Lumières / 11 avenue de Canteranne - 33600 Pessac France Tel +33 (0)5 57 00 01 40 / Fax +33(0)5 57 00 01 41

Siège Social : 12 avenue de la libération – 33700 Mérignac – France

E-mail : [luxener@luxener.com](mailto:luxener@luxener.com) [www.luxener.com](http://www.luxener.com)

# Données photométriques 40° x 40°

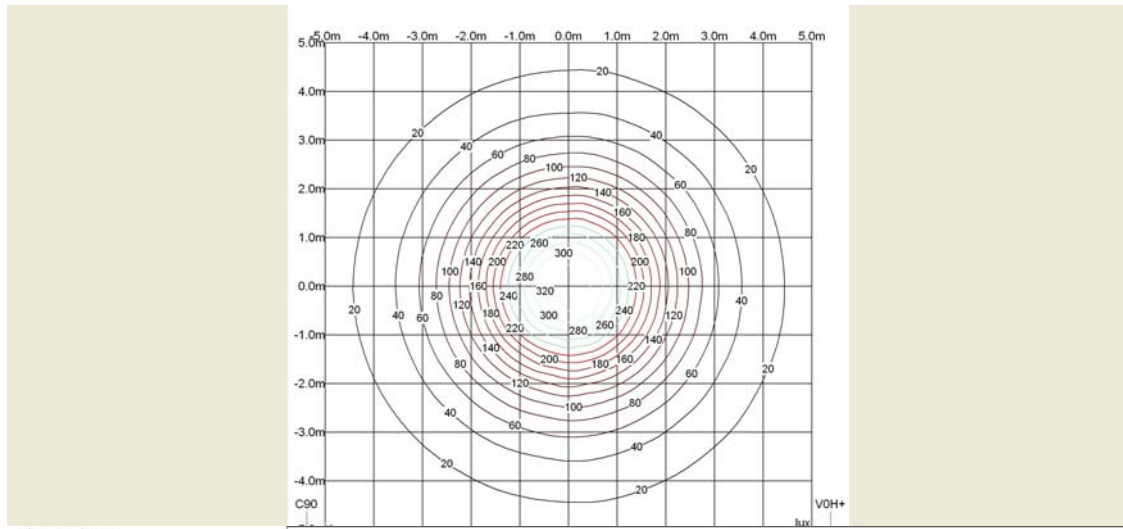
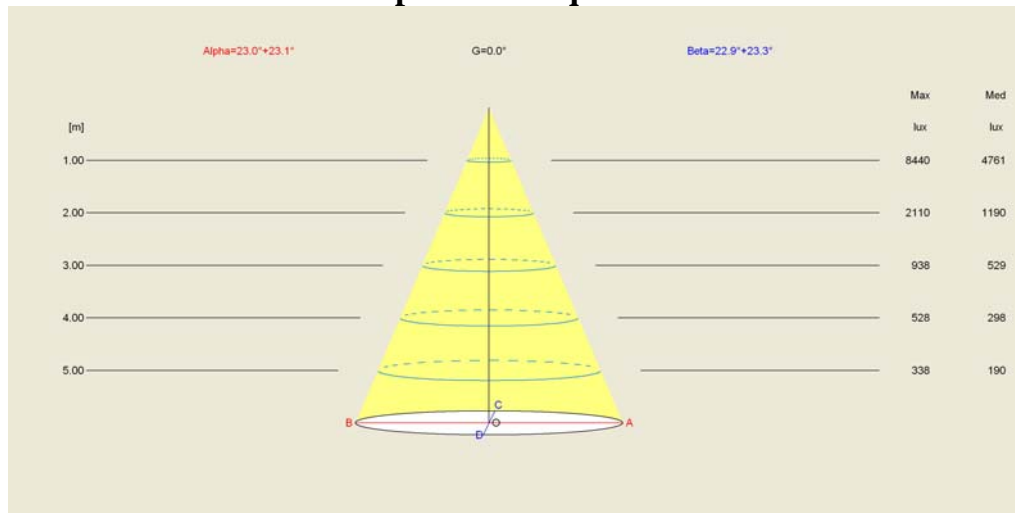

1mm x 1mm

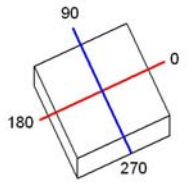

C Demi-plans

180.0 — 0.0

270.0 — 90.0

Flux 7122.60 lm  
Maximum 8446.15 cd  
Position C=0.00 G=0.00  
Rendement: 100.01%  
Date: 01-01-1998  
Asymétrique

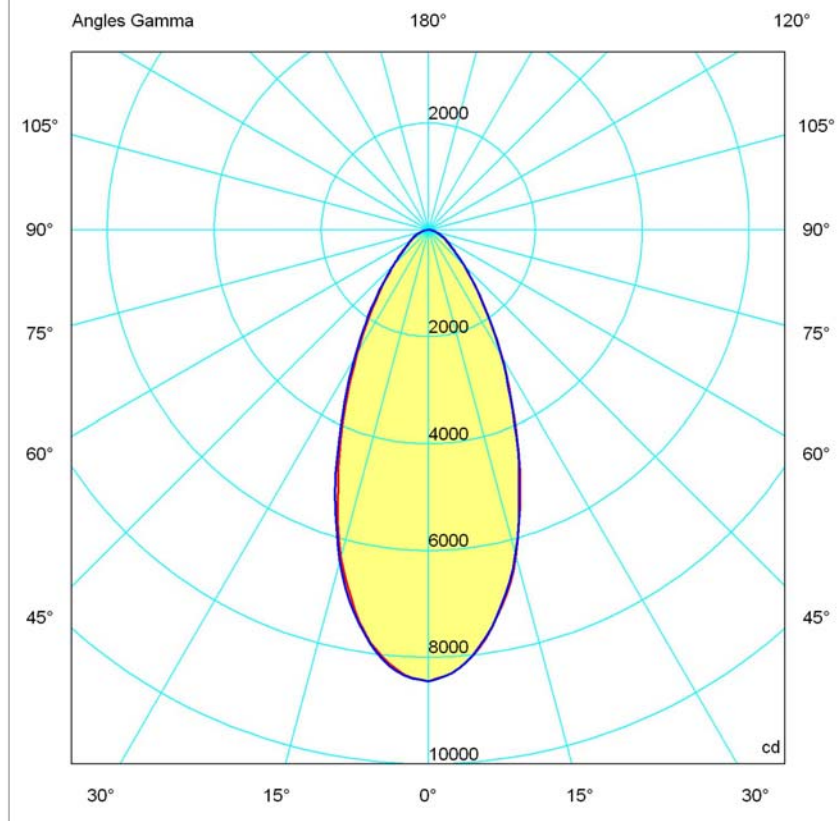

Cité de la Photonique - Pôle de Compétitivité Route des Lasers - 9 allée des Lumières / 11 avenue de Canteranne - 33600 Pessac France Tel +33 (0)5 57 00 01 40 / Fax +33(0)5 57 00 01 41

Siège Social : 12 avenue de la libération – 33700 Mérignac – France

E-mail : [luxener@luxener.com](mailto:luxener@luxener.com) [www.luxener.com](http://www.luxener.com)

5

Luxener se réserve le droit de changer les caractéristiques de ses produits, selon l'état de l'art du moment, sans avis préalable

REFERENCE DU DOCUMENT : DT-AZ-SOL60POLG-v0

# Données photométriques 60° x 60°

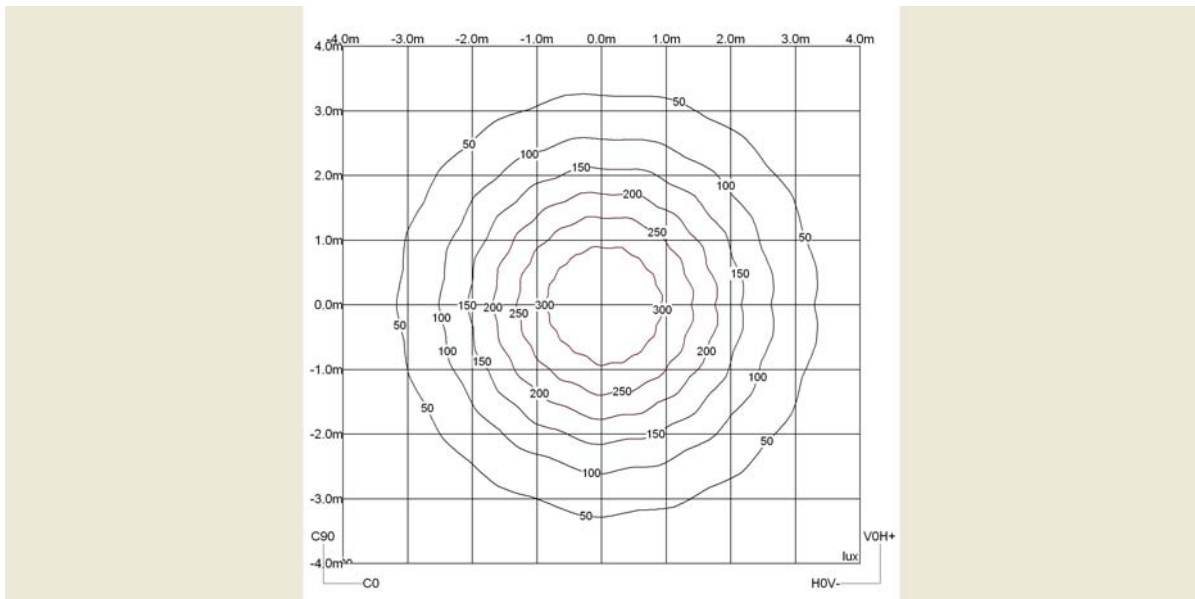
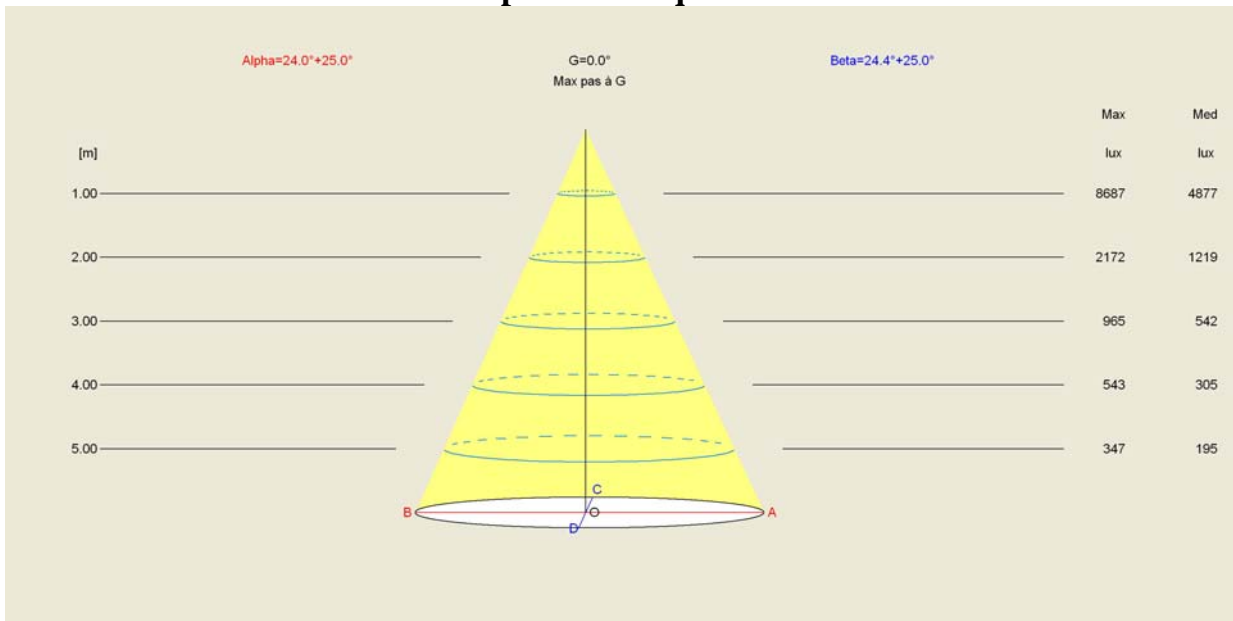

1mm x 1mm

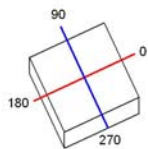

C Demi-plans

180.0 — 0.0

270.0 — 90.0

Flux 6854.00 lm  
Maximum 8703.90 cd  
Position C=270.00 G=0.90  
Rendement: 100.52%  
Date: 01-01-1998  
Asymétrique

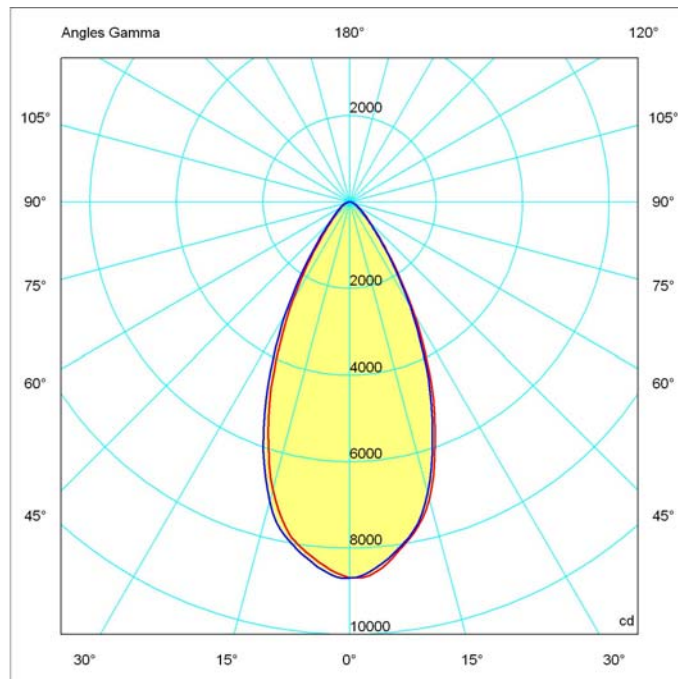

Cité de la Photonique - Pôle de Compétitivité Route des Lasers - 9 allée des Lumières / 11 avenue de Canteranne - 33600 Pessac France Tel +33 (0)5 57 00 01 40 / Fax +33(0)5 57 00 01 41

Siège Social : 12 avenue de la libération – 33700 Mérignac – France

E-mail : [luxener@luxener.com](mailto:luxener@luxener.com) [www.luxener.com](http://www.luxener.com)

# Données photométriques 60° x 135°

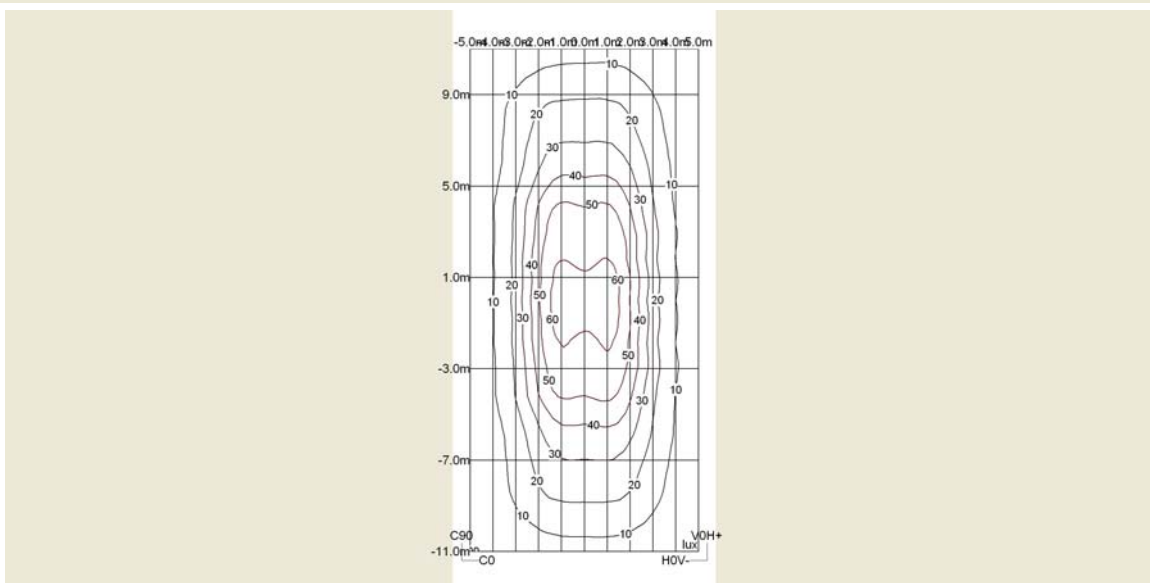
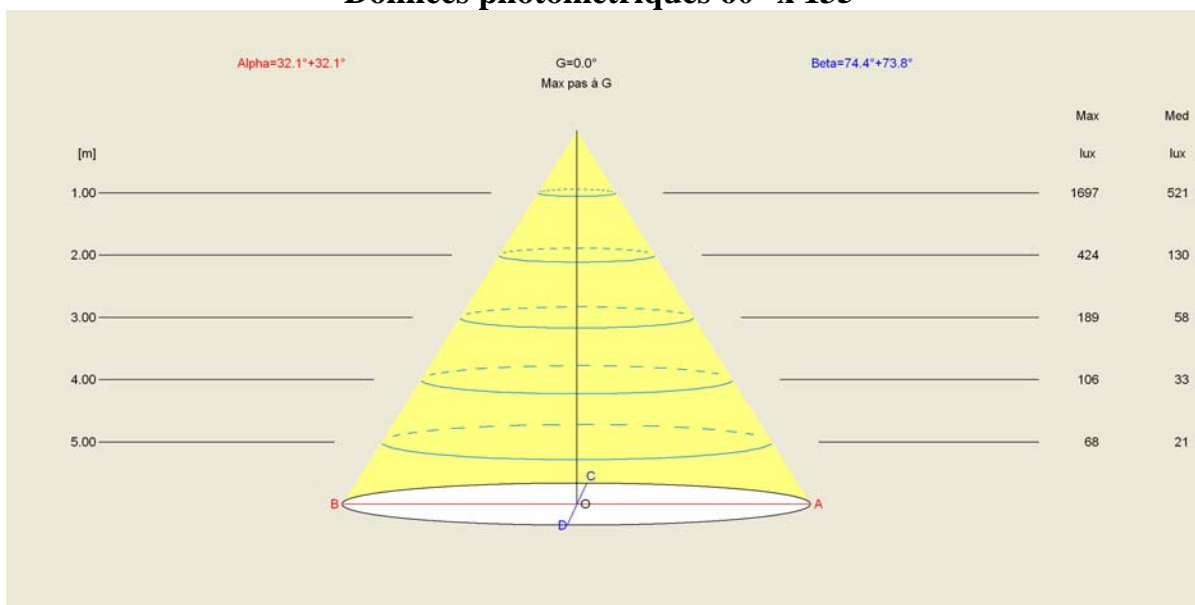

600mm x 400mm

C Demi-plans

180.0 — 0.0  
270.0 — 90.0

Flux 6390.00 lm  
Maximum 4368.60 cd  
Position C=275.00 G=60.00  
Rendement: 95.08%  
Date: 01-01-1998  
Asymétrique

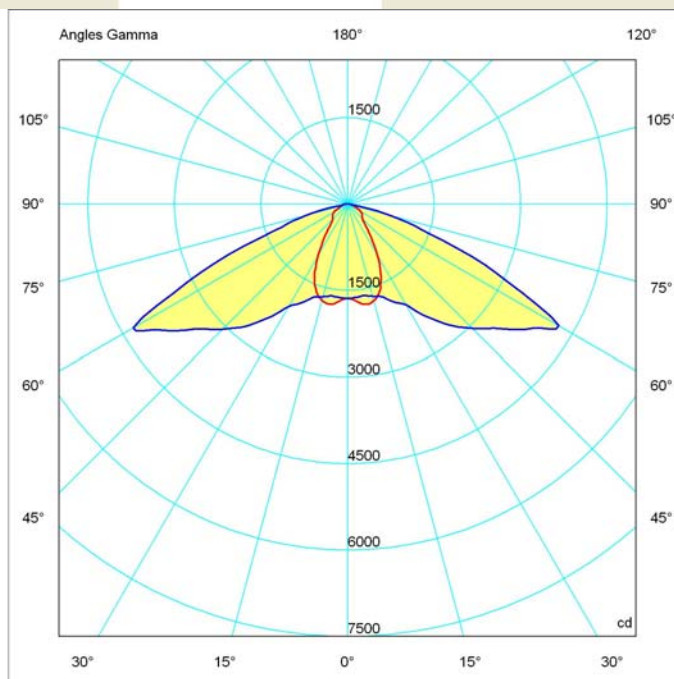

Cité de la Photonique - Pôle de Compétitivité Route des Lasers - 9 allée des Lumières / 11 avenue de Canteranne - 33600 Pessac France Tel +33 (0)5 57 00 01 40 / Fax +33(0)5 57 00 01 41

Siège Social : 12 avenue de la libération – 33700 Mérignac – France

E-mail : [luxener@luxener.com](mailto:luxener@luxener.com) [www.luxener.com](http://www.luxener.com)

# Données photométriques 85° x 135°

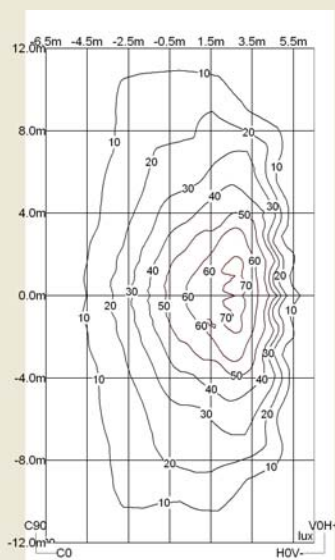
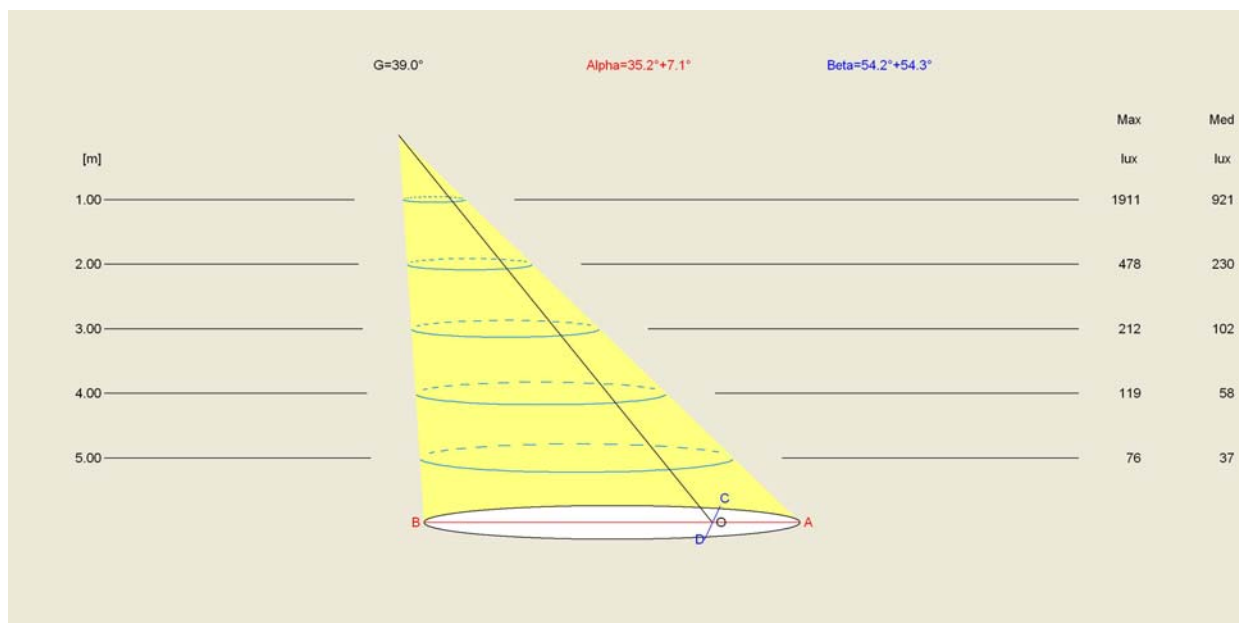

500mm x 400mm

C Demi-plans

180.0 — 0.0  
270.0 — 90.0

Flux 6401.40 lm  
Maximum 4621.48 cd  
Position C=80.00 G=62.10  
Rendement: 100.00%  
Date: 01-01-1998  
Asymétrique

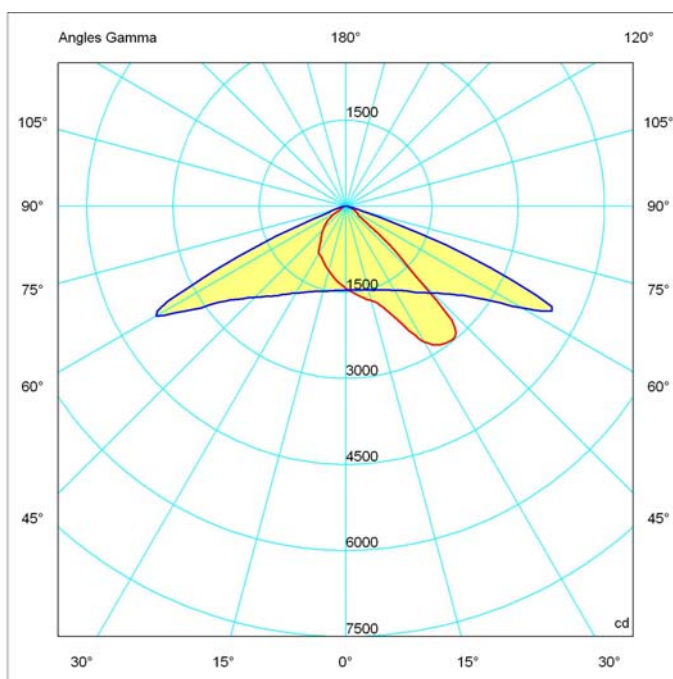

Cité de la Photonique - Pôle de Compétitivité Route des Lasers - 9 allée des Lumières / 11 avenue de Canteranne - 33600 Pessac France Tel +33 (0)5 57 00 01 40 / Fax +33(0)5 57 00 01 41

Siège Social : 12 avenue de la libération – 33700 Mérignac – France

E-mail : [luxener@luxener.com](mailto:luxener@luxener.com) [www.luxener.com](http://www.luxener.com)